

**CALIFORNIA  
UMBRELLA**

INSTRUCTION MANUAL  
**GROVE SERIES**  
MARE908/758/604



Question about your product? Visit [www.californiaumbrella.com](http://www.californiaumbrella.com) and chat with us today.

# COMPONENTS

## Box Contents

**1** Frame

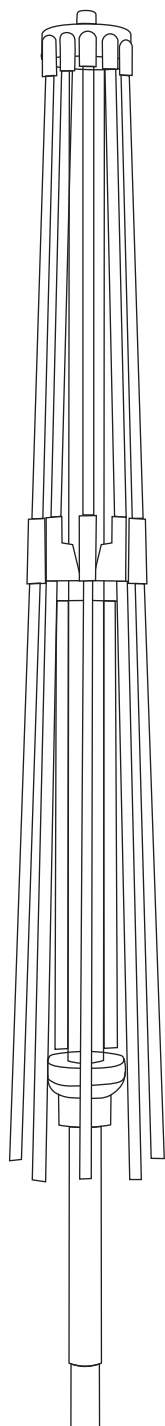

**2** Canopy

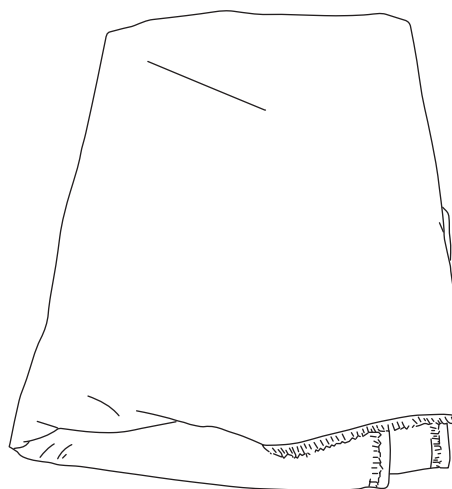

**3** Finial Cap

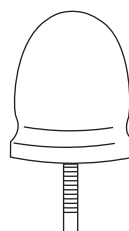

**4** Bottom Pole



# CANOPY ASSEMBLY

---

## Step 1

Place the umbrella frame on a stable, elevated surface with the top of the frame extending over the edge.

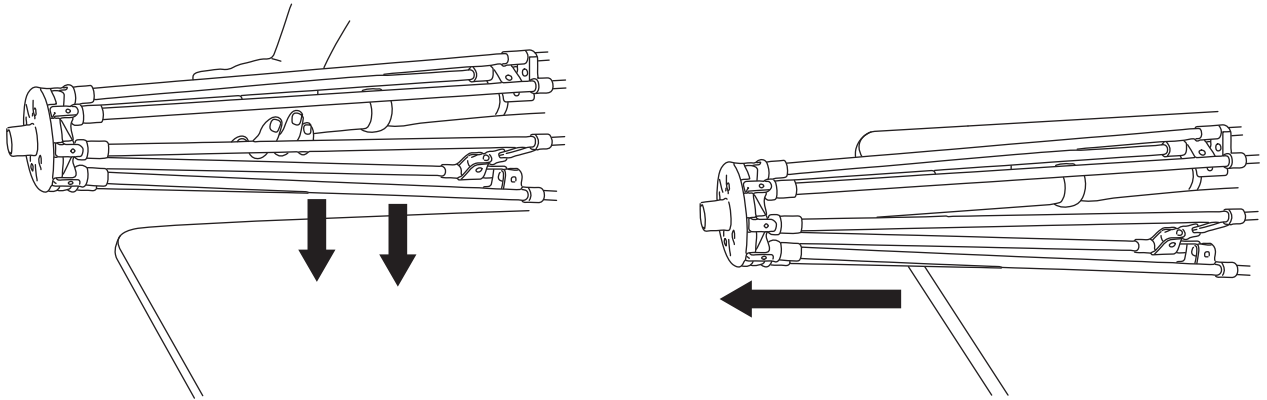

## Step 2

Unfold the canopy. Insert one arm underneath the canopy and locate the small opening at the center. Please note, the canopy should be inside out in this step.

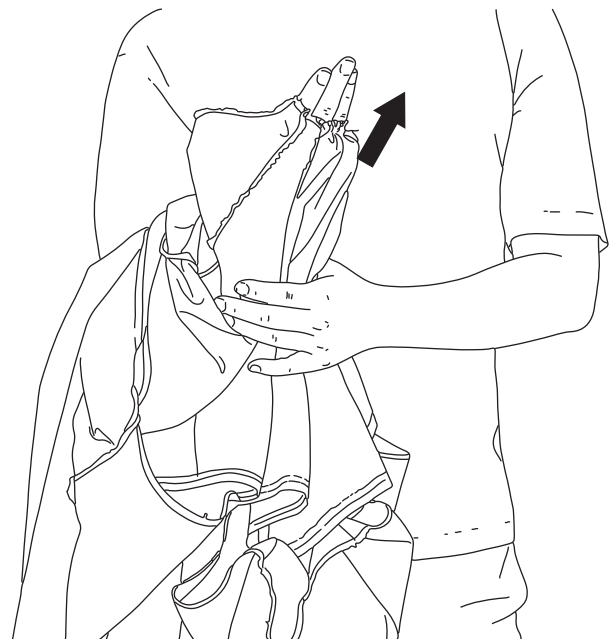
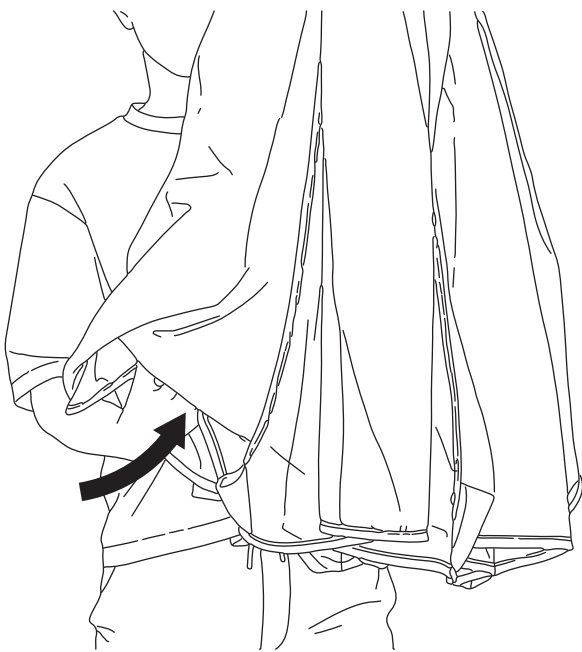

# CANOPY ASSEMBLY

---

## Step 3

Use the same hand that is inside the canopy to grip the protruding thread at top of the frame. While maintaining the grip, use the other hand to flip the canopy over the frame.

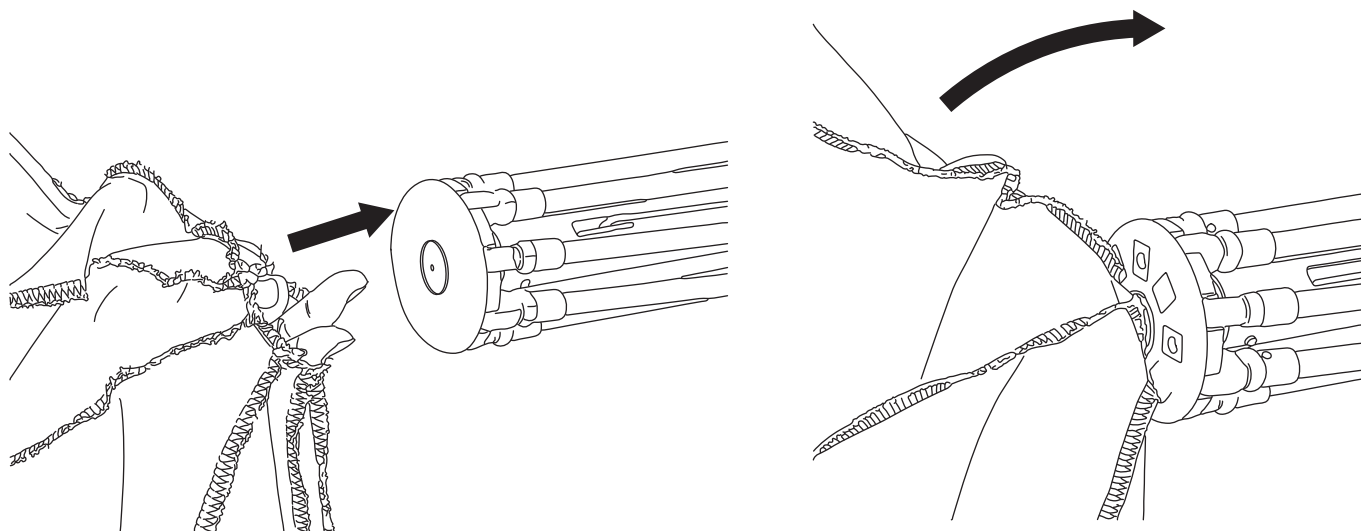

## Step 4

Adjust the small opening of the canopy until the threaded end is fully exposed. Screw the finial cap on clockwise to secure the canopy.

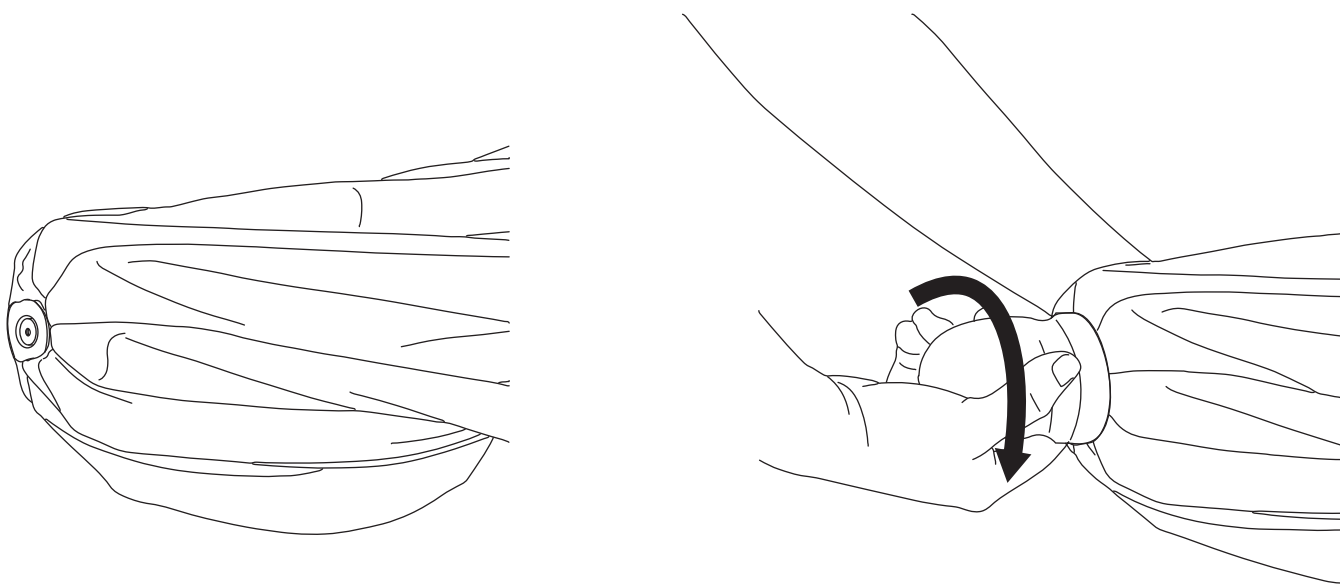

# CANOPY ASSEMBLY

---

## Step 5

Temporarily lift the assembled frame and canopy to allow the canopy to fully drape over the frame.

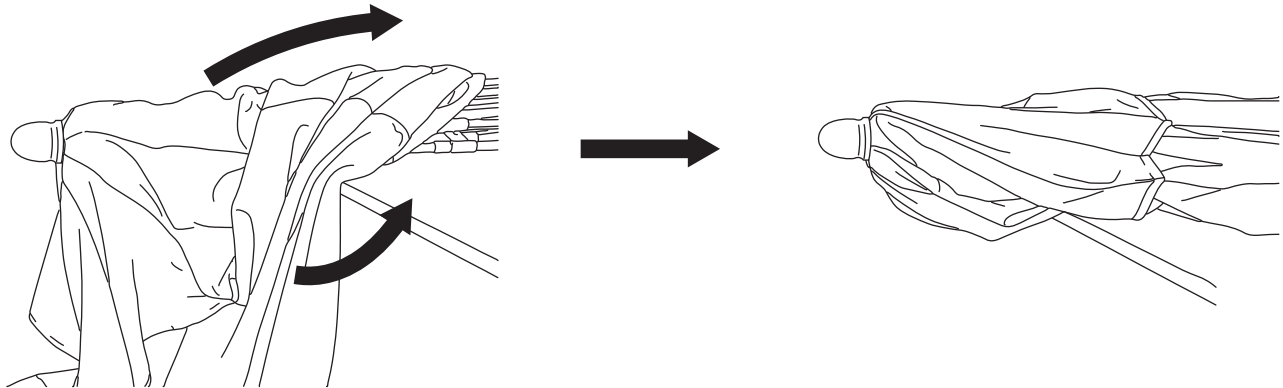

## Step 6

Locate the rib pockets at the bottom of the canopy. One at a time, pull each pocket down and insert the corresponding rib to complete the assembly. To remove the canopy, follow these steps in reverse order.

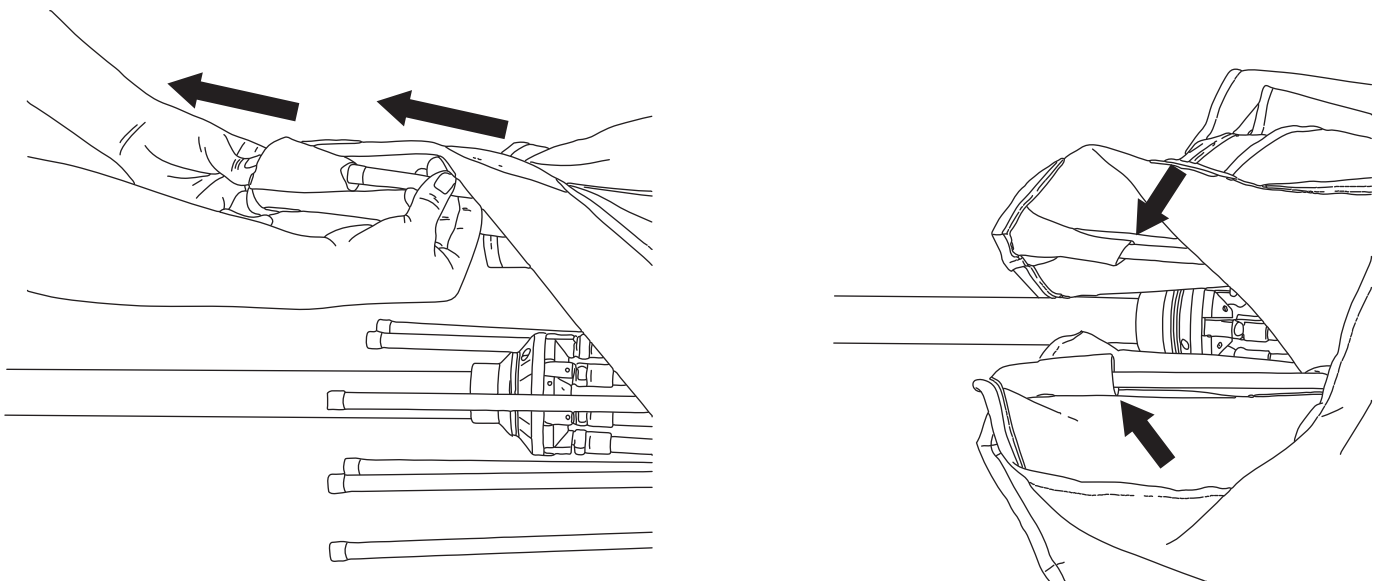

# INSTALLATION

## Step 1

With the main frame laying down, insert the bottom pole over the bottom portion of the frame.

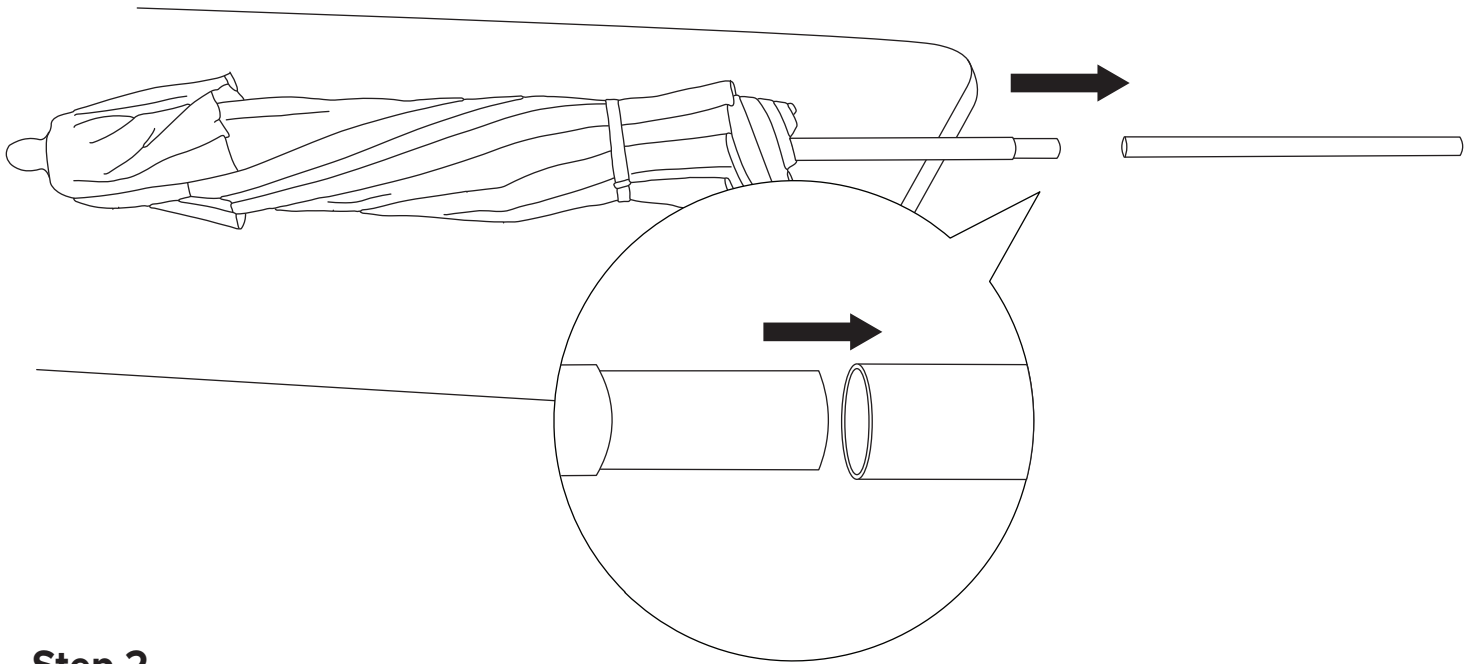

## Step 2

Twist the bottom pole clockwise to thread the screw into the hole of the frame.

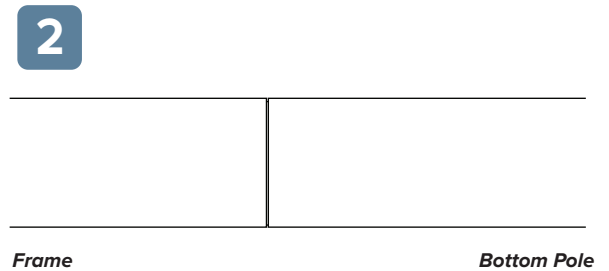
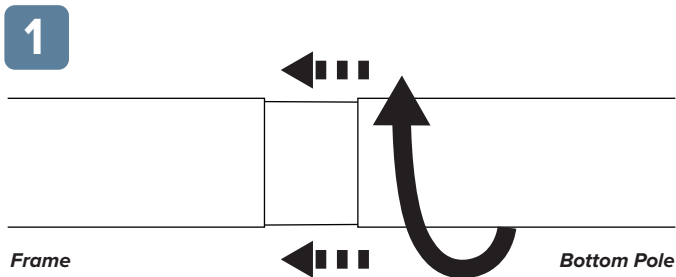
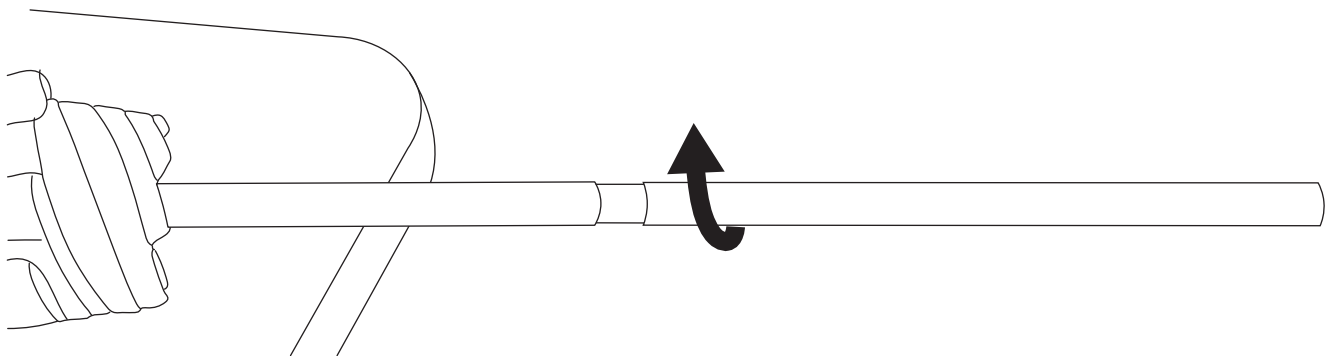

# INSTALLATION

---

---

## WARNING

*Base is required for this umbrella and sold separately.  
Umbrella should always be closed and secure with wind-tie  
in windy conditions*

---

### Step 3

Place the umbrella pole into a suitable, stable base (sold separately) that fits its diameter. Make sure the pole is fully inserted, then tighten any securing knobs or fasteners on the base to lock the frame firmly in place and prevent movement.

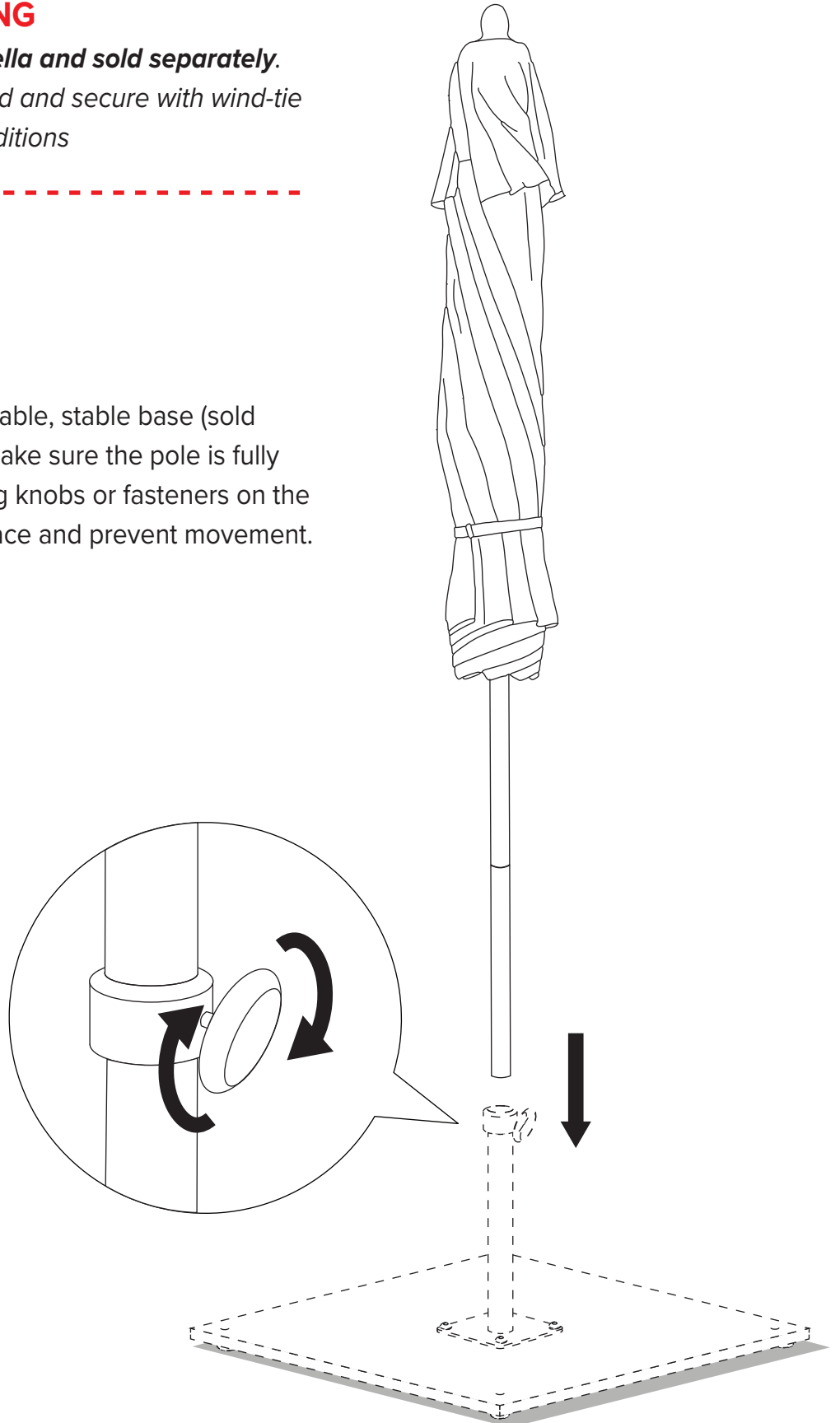

Scan to Shop  
Umbrella Bases



# OPERATION Opening and Closing Umbrella

## Opening

Stand beneath the umbrella and locate the hub that connects the ribs. Firmly grip the hub and push it upward until it passes the first pin hole. Insert the connected pin into the hole to keep the canopy open. Please note, pin holes are meant to be used lowest to highest as fabric may stretch over time.

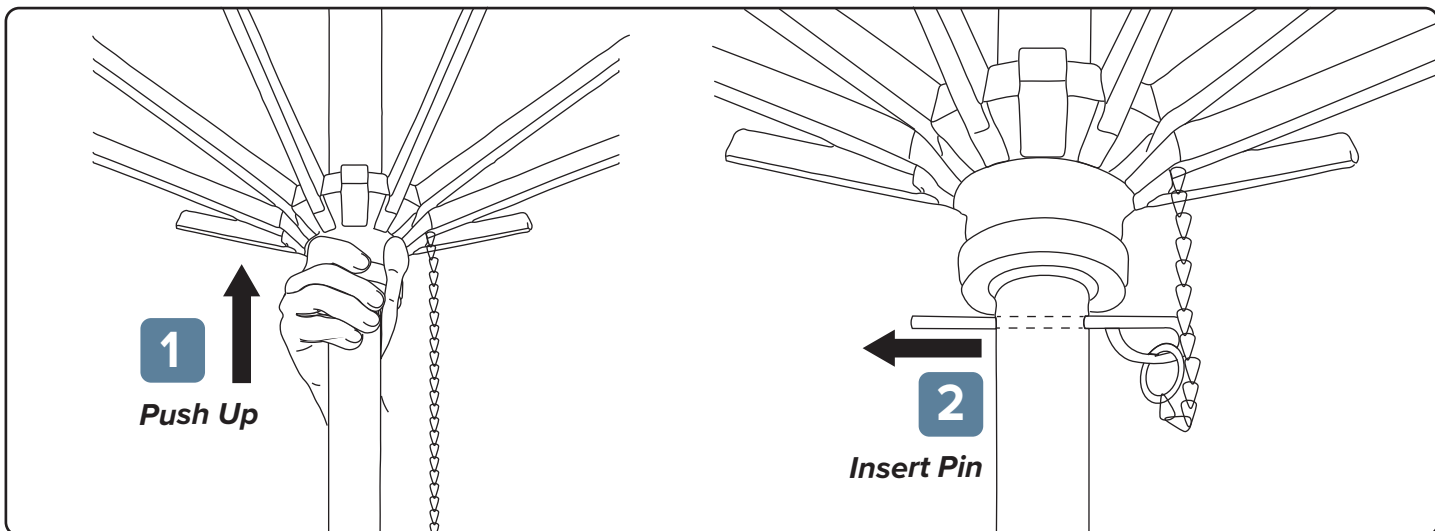

## Closing

To close the canopy, firmly hold the hub to support its full weight, then pull the pin out of the hole. While keeping control of the hub, slowly lower it until the canopy is fully collapsed. To avoid injury, please operate slowly and carefully.

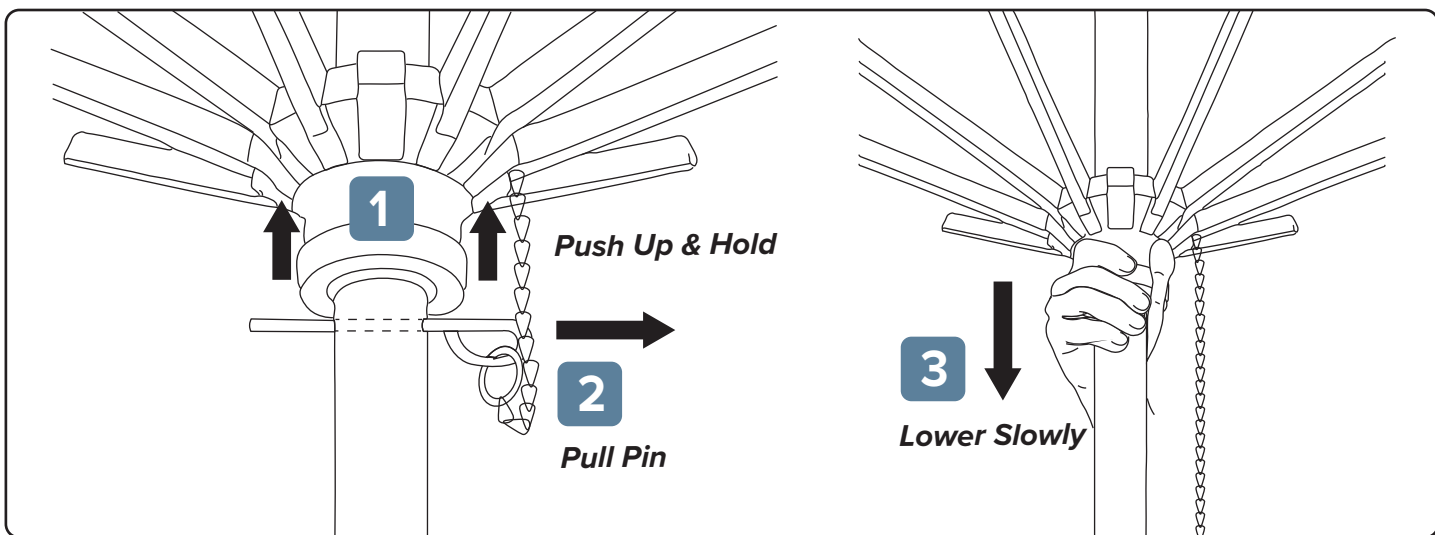

# CARE & MAINTENANCE

---

## Care Tips

- Use an appropriate base or anchoring system to secure the umbrella. Verify the recommended base weight for your specific model. A minimum base weight of 70 lbs is required to maintain warranty coverage in commercial use case settings and environments.
- Ensure the umbrella pole is fully and securely inserted into the base before use. Tighten any base tightening knobs to secure the umbrella. Confirm the canopy is correctly positioned and evenly seated on all frame ribs before opening.
- For umbrellas with a pin-stop collar: start at the lowest pinhole for everyday functional use. As fabric naturally stretches over time, a higher pinhole can be used for a tighter, more aesthetic fit — however, a looser fitting is recommended in commercial & breezy conditions, as it allows the fabric to flex with the wind and improves long-term durability.
- The base or anchor for the umbrella must rest on a flat, stable surface. Always move the umbrella by fully closing, uninstalling, and lifting/placing in the desired area — never drag or reposition while open.
- You may add a fabric defense to your canopy for an added layer of protection against oil and water-based stains if desired. Visit our website to purchase a bottle of Pacifica Preserve and Protect Fabric Defense.

## General Warnings

- A minimum base weight of 70 lbs is required to maintain warranty coverage for anchor-related incidents. Always verify the recommended base weight for your specific umbrella model.
- May cause damage or injury when used improperly.
- Not meant for use in windy or inclement weather conditions. Always close and secure the umbrella before any high-wind event or storm.
- When not in use, close the canopy, cover, and store outdoor furniture in a dry and clean area.
- Do not use harsh cleaning products on the surface of your frame or canopy.

# CARE & MAINTENANCE

---

## How to Clean

- **Frame**

- To keep the frame looking its best, wipe with a clean damp cloth and a solution of mild soap and water<sup>1</sup>. Dry thoroughly with a clean dry cloth. While the canopy is installed, use a soft bristle brush to regularly remove loose dirt, leaves, and debris.
- To remove water spots, scrub the frame with a clean cloth or soft bristle brush using a solution of white vinegar and water<sup>2</sup>. Dry thoroughly with a clean dry cloth.

- **Canopy**

- While the canopy is installed, use a soft bristle brush to regularly remove loose dirt, leaves, and other debris from the fabric.
- For spills and stains, spray a mild cleaning solution of mild soap and water<sup>1</sup> and scrub with a soft bristle brush or clean cloth.
- For more severe cases, use Pacifica: Restore and Renew Fabric Cleaner. Spray 10 inches from the surface, scrub with a soft bristle brush, and thoroughly rinse with clean water.
- Machine Wash Cold and Air Dry Only.

- **Cleaning Solution**

- Mild Soap and Water<sup>1</sup>: ¼ cup mild soap : 1 gallon water
- White Vinegar and Water<sup>2</sup>: 1 cup vinegar : 1 cup water

# WARRANTY

---

## Overview

California Umbrella's limited warranty gives you specific legal rights and you may also have other rights, which vary from state to state.

This limited warranty can also be found at [www.californiaumbrella.com/en/terms-of-sales#warranty](http://www.californiaumbrella.com/en/terms-of-sales#warranty) and in the documentation we provide with the products.

We warrant that during the warranty period, the individual components of the products purchased from the site will be free from defects in materials and workmanship.

We limit the duration and remedies of all implied warranties, including without limitation the warranties of merchantability and fitness for a particular purpose, to the duration of this limited warranty. Our responsibility for defective products is limited to repair, replacement or refund as set forth in this warranty statement. Neither any performance or other conduct, nor any oral or written information, statement or advice provided by us, our agents, or employees will create a warranty, or in any way increase the scope or duration of this limited warranty.

## Frames

- Aluminum frames: 1-year limited warranty
- Fiberglass Ribs: 3-year limited warranty
- If a residential grade umbrella is used for commercial purposes, the warranty is reduced to 90 days.

## Canopies

- All canopies: 1-year limited workmanship warranty
- Olefin fabric: 1-year limited warranty
- Pacifica fabric : 4-year limited warranty
- Sunbrella fabric : 5-year limited warranty
- Sunbrella Awning fabric : 10-year limited warranty

Contact us through our ticketing system on [californiaumbrella.com](http://californiaumbrella.com) for warranty inquiries.